



RURAL LSC

AFFORDABLE HOUSING DEVELOPERS'

BROADBAND HANDBOOK





AFFORDABLE HOUSING DEVELOPERS' BROADBAND HANDBOOK

Prepared for LISC by CTC Technology and Energy

January 2022

ctc technology & energy
engineering & business consulting

RURAL LISC



Contents

6	1. Introduction
9	2. Elements of a Multi-Tenant Environment broadband project
9	2.1 Community and stakeholder engagement
10	2.2 Design and engineering
10	2.2.1. Feasibility and technical assessment
15	2.2.2. Cost estimate development
16	2.3 Financial modeling
18	2.4 Business or strategic plan development
19	2.5 Partnership development
21	3. Policy overview
21	3.1 Federal policy impacts
21	3.2 State policy impacts
22	3.3 Local policy impacts
23	4. Technology overview
23	4.1 Fiber-to-the-premises (FTTP)
24	Figure 1: Connecting an FTTP network to an MTE with dedicated gigabit capacities
25	4.2 Hybrid fiber-coaxial (HFC)
26	Figure 2: Distribution of shared vs. dedicated capacity in an HFC network
27	4.3 Digital subscriber line (DSL)
28	4.4 Fixed wireless overview
29	4.5 Mobile broadband

30	5. Recommendations for housing developers
31	Figure 3: Detailed diagram of lateral construction components
33	6. Overview of infrastructure construction
33	6.1 What is conduit?
35	6.2 Fiber optic construction in the right-of-way
36	6.3 Outdoor wiring fiber termination points
36	6.4 In-building wiring
37	6.4.1. Residential buildings with shared entrances
37	Figure 8: Main distribution frame layout
38	Figure 9: Indoor cabling overview for residential buildings
38	Figure 10: Conduit and pathways for separate-entrance housing units
38	6.4.2. Residential buildings with separate entrances
39	6.4.3. Single-family homes and townhomes
39	Figure 11: Standalone Unit Broadband Model
41	7. Supporting digital inclusion
42	7.1 Case study: City of Seattle
44	7.2 Case study: City of Portland, Oregon
45	7.3 Case study: Detroit, Michigan
47	8. Funding opportunities for broadband
47	8.1 Infrastructure
48	8.2 Economic development
49	8.3 Digital equity/adoption stimulation
50	8.4 Subscription support and affordability interventions
50	8.5 Device distribution
51	9. Conclusion

1

Introduction

When developing a housing project, utilities such as water and electricity are an integral part of the process. Today, broadband infrastructure must be considered the same way. Housing developers have a role to play in proactively designing projects that support a competitive, accessible broadband environment for residents. This handbook outlines the elements of a broadband initiative, an overview of technical considerations, policy options, digital inclusion practices, and funding opportunities for broadband initiatives that housing developers, owners, and the public and private partners should take into account.

Housing developers have a role to play in proactively designing projects that support a competitive, accessible broadband environment for residents. This guide focuses on a general process for technology selection and an economic alternative to internal rewiring by retrofitting buildings with external conduits.

A variety of federal and state funding sources have regulations that require infrastructure or minimum speeds for connectivity. For example, Housing and Urban Development (HUD) regulations¹ require broadband-ready infrastructure for HUD-financed developments and many new infrastructure builds require futureproof wireline symmetric speeds. A variety of affordable housing developments are addressed in this handbook, including those more commonly found in urban and rural areas. The focus is on multi-tenant environments (MTE) such as apartment complexes, semi-attached houses, and multi-family homes.

As the Federal Communications Commission (FCC) revises its MTE competitive broadband access rules, high-speed, building-wide open access networks will allow buildings to comply with any new access requirements and avoid costly and redundant installations from multiple internet service providers (ISP) offering competitive, futureproof services to each unit.² These can be achieved with fiber or ethernet wiring and can have a positive impact on housing values and are a net benefit to developers. It is important, however, that new developers incorporate the communications wiring design at a relatively early stage and not as an afterthought. An experienced network engineering company can provide the necessary specifications for vaults, terminations at the street level, and space for communications equipment inside the building and—if desired—placements for Wi-Fi access points to cover common areas.

The affordability of robust, high-bandwidth wiring, relative to cheaper options, and the difficulty of upgrading broadband wiring after construction both strongly incentivize new developers to invest in a futureproof network that will meet the needs of residents well into the future. For refurbishing existing housing, the optimal technical solution would therefore be rewiring to bring the housing up to the same ideal standards. This, however, is costly, and not always practicably attainable. Instead, developers will often reuse existing copper or coaxial wiring or bypass wired solutions in favor of economical wireless solutions. Each of these have their own strengths and weaknesses but fall short of the gold standard for new developments and complete rewiring in older buildings.

This guide will therefore focus on a strategically informed general process for technology selection and an economic alternative to internal rewiring by retrofitting buildings with external conduits. The latter will achieve the same gold standard of open access, futureproof networks as in new developments, but without the high cost of rewiring inside walls and crawlspaces. A very brief discussion of fixed wireless solutions and reuse of existing wiring will be touched upon, but a more in-depth discussion of these is planned.³

- 1 “81 FR 92626: Narrowing the Digital Divide Through Installation of Broadband Infrastructure in HUD-Funded New Construction and Substantial Rehabilitation of Multifamily Rental Housing,” Federal Register, December 20, 2016, <https://www.govinfo.gov/app/details/FR-2016-12-20/2016-30708> (accessed January 12, 2022).
- 2 The FCC sought comments for potential new regulations to close loopholes to ensure open access and incentivize competition. See <https://www.federalregister.gov/documents/2021/09/20/2021-20147/improving-competitive-broadband-access-to-multiple-tenant-environments>.
- 3 There are currently no systematic vendor-agnostic guidelines available for either of those approaches. Most industry literature focuses on a single technology, vendor, or solution, often pitched to ISPs and therefore exclusive to a single provider.



2

Elements of a Multi-Tenant Environment broadband project

Every broadband project includes several distinct planning phases which seek to develop the understanding of community needs and wants and their sustainable solutions. The following sections and subsections describe the various components of a broadband plan. These include:

- Community and stakeholder engagement
- Design and engineering
- Financial modeling
- Business and strategic planning development
- Partnership development

2.1 Community and stakeholder engagement

Before technical work is done on a broadband planning or development project, it is a best practice to engage with the local stakeholders. This creates buy-in, engagement, and champions within the community. The stakeholder engagement process is iterative and ongoing throughout the life of the project. This will help ensure the community members are part of the process and outcomes, and heighten the feeling of something being done with, rather than to, the community/county/area/population.

Throughout the stakeholder engagement process, various issues will come up, including digital literacy needs, digital inclusion, and an overall sense of what is and is not working. By taking the time to be part of this process, the people who will be served will help inform the reality on the ground to ensure planning and development are not only done well but done in the best way possible for the community.

The stakeholder engagement process for broadband is typically done like many other engagement

Engaging with local stakeholders creates buy-in, engagement and community champions.

processes, by convening forums, asking questions, receiving feedback, and adjusting plans/development. In addition, the broadband planning and development process will frequently include requests that the residents and businesses of the community partake in speed tests at various points of the day. This data is valuable to evaluate the speeds of the existing providers as well as better understand who is served, underserved, and unserved. In addition to engaging with the stakeholders and speed tests, the existing broadband infrastructure will be mapped.

Mapping the existing assets, including ownership, will help inform engineering and plan development. In conjunction with speed tests, mapping will paint an overall picture of what areas are served, underserved, and unserved, and will help inform final plans to solve broadband issues for affordable housing in the jurisdiction.

Finally, as part of the iterative process that is stakeholder engagement, reports, preliminary plans, and final plans should be shared with the stakeholder group. This will allow for information sharing, buy-in, and engagement throughout the whole process. Final plans should be reviewed and shared with the stakeholder group to make certain there is local support.

2.2 Design and engineering

Design and engineering will evaluate needs, building/development information, age of the structures, inspect existing infrastructure, and develop plans based on diverse criteria outlined in this section. These plans will include cost estimates for a variety of solutions. Planners and network engineers use information about building design, project plans, speed tests, and map data to create a technical connectivity solution and cost estimate for a particular broadband project. When designing a network for Multi-Tenant Environments (MTEs), the design and engineering phase will include both the broadband connection from the building to the public right-of-way and an in-building technical design to deliver services to residents. If no suitable existing broadband infrastructure is available at the public right-of-way, an engineering solution may encompass extending network connectivity to the building-adjointing public right-of-way as well.

2.2.1. FEASIBILITY AND TECHNICAL ASSESSMENT

Network engineering typically consists of two distinct phases. The feasibility and technical assessment will examine existing building design, broadband connectivity in and near the building(s), and in-building conditions for wiring and/or wireless propagation. Once one or more technical solutions have been selected through this process, a design and cost estimate can be generated.

The feasibility study will engage with the public entities, developer, owner, and other entities as needed (such as existing ISPs) to understand business model constraints that would affect feasible technical options, such as:

- Project drivers, needs, and objectives
- Various and/or preferred business models including administrative burden, ownership, operations, maintenance, funding, cost recovery/revenue, open access/exclusive partnership, and participation of local government or nonprofits
- Exclusive partner/operator agreements
- Other exclusive agreements
- Ownership of in-building or in-development communications assets
- Ability to leverage public/nonprofit wireless or wireline infrastructure
- Funding-source technical requirements
- Building and/or housing development common communications space access
- Local, state, and federal regulatory mandates and limitations
- Potential property updates, including MTE buildings
- Prior engagement and contracts with ISPs

Next, the technical assessment will encompass three segments for ensuring broadband connectivity for end-users: Broadband infrastructure to the public rights-of-way, connectivity (drop) to the building, and in-building connectivity to the units.

2.2.1.1 Broadband to the public rights-of-way

Building and development owners typically are well-aware of what broadband providers are available. In urban areas, there are usually digital subscriber line (DSL—internet delivered over copper phone lines), coaxial cable, and sometimes fiber optic providers near or even in the building. A combination of FCC mapping tools, local speed tests, and local/state maps can identify what operators are present, and what speeds they provide, in the general area. Contacting these ISPs and/or conducting an onsite inspection can pinpoint the location of the infrastructure. If sufficient broadband infrastructure is not present, an assessment would recommend/include a design for ensuring such connectivity. The specific design would depend on the project objectives and business model constraints, but could consist of a variety of different options:

- Extend infrastructure from the public-right-of way outside the building into the building, either through a specific provider’s infrastructure or publicly owned infrastructure
- Extend middle-mile broadband infrastructure to the building or development:
 - Using publicly owned middle-mile would enable any ISP that can connect to the strategically colocated aggregation point to provide services
 - Leasing/buying carrier-provided middle-mile
 - Constructing new middle-mile infrastructure to a convenient hub/aggregation site for any ISP to connect to the building or development

While a variety of technical options are available, any line extension from the building to one or more networks is typically a fiber optic connection which can be a variety of solutions including an exclusive contract with one ISP, competitive with two or more ISPs, or open-access where any ISP can serve any of the residents.

2.2.1.2 Connectivity to the development or building

If appropriate infrastructure is not available at the curb or street level that provides connectivity back to the development or building, each potential ISP will need to extend its network to the building, either underground or on utility poles, based on what is available. The incumbent telephone provider likely already has connectivity to the building(s) and uses the copper lines to deliver DSL at relatively low speeds. As MTEs and many new housing developments are typically set back from the main roads with parking lots and other paved structures separating the building from the public right-of-way, an extension of infrastructure from the right-of-way to the building or development can be expensive. Options for connecting to an ISP for the building/development are:

- **Utilizing existing copper (telephone wire) connections**
 - Typically, only the incumbent telephone provider may have this option.
 - Depending on the age of the infrastructure and provider equipment, this solution does not meet the Infrastructure Investment and Jobs Act (IIJA) broadband speeds.
- **Utilizing an existing communications conduit** if one is available and has space to bring new infrastructure to the building or development
- **Attaching new infrastructure from utility poles** to the building and terminating it in the communications room or other key communications location

The ideal scenario with existing buildings is likely retrofitting, unless there are existing plans and funds for a substantial rehabilitation. A fiber-to-the unit architecture allows for multiple ISPs to serve the residents at competitive price points. Fiber optics will help ensure all residents have acceptable levels of service at prices affordable to all.

- This will be determined by the utility pole owner if there is space in the communications area on the poles.
 - If there is not, the pole owner may require pole upgrades to allow for more infrastructure on the poles.
 - Pole owners may require additional steps, such as entering into pole attachment agreements to hang new lines on the poles.
- **Installing a new underground conduit**
 - Ideally, any new build would have conduit installed from the right-of-way to the building(s). See Section 3 for more information.
 - Fiber can either be installed at the same time with sufficient strands to accommodate any provider needs, or space can be set aside for providers to install fiber.
 - **Utilizing a fixed wireless solution**
 - This is typically an antenna mounted on the roof that connects to the communications infrastructure, such as existing coax cable wiring, to provide a wired or wireless solution to the residents.
 - Such connections are typically deployed by wireless internet service providers (WISPs). Due to different technologies and frequencies utilized by different providers it is very challenging to create an open-access wireless network. A wireless solution would likely require the building(s)/development to enter into a contract with the WISP.

From an open or competitive access perspective, the ideal development is fiber optic infrastructure and architecture that connects at the street level or inside the building. A conduit with sufficient space for future fiber installation can be quite attractive as well. In this model, there is no need for a third party to provide any operations, as the service and requirements to do so are operated by each ISP.

2.2.1.3 Broadband infrastructure in existing multi-resident buildings

An in-building assessment will typically examine existing wiring, including the transmission medium and technology to connect to the building's communications room/facility. Existence of ethernet cabling is ideal, assuming the cabling belongs to the building or building owner and can be easily used by any ISP. As much of the affordable housing was built prior to fiber-to-the-unit or building, there are a few options available that an assessment can explore:

- **Rewire the buildings, including to the units**

- Installing all-new fiber optic wiring throughout a building can be cost-prohibitive and potentially difficult based on building design. However, if funding is available, including grants, fiber optic infrastructure is the most futureproof option. In the case of installing new fiber optics, owner/developer/building owned infrastructure to the unit is optimal.

- **Retrofit the building**

- Short of installing wiring in the interior, new wiring can be installed by placing conduits on the exterior walls to reach the unit/communications facility on each floor. While generally significantly cheaper than a rewiring project, the costs can still be significant, including permitting and other design standards from the local jurisdiction. Grant funding is an attractive option to finance such projects.

- **Reuse existing infrastructure**

- Coaxial cable

Unless the coaxial wiring was installed by the developer, it is/was typically deployed by a cable television provider. It is generally restricted to that ISP and is not useful to more competitive or public broadband options.

A building owner can also explore partnerships with a cable provider to offer affordable and high-quality connectivity to the individual units.

- Copper phone lines

Depending on the age and condition, existing phone lines may be useful to reuse for a multi-provider scenario.

On such copper lines, speeds rapidly deteriorate with distance between the unit and the equipment in a communications closet. An assessment would include both the quality of existing wiring and distances that require amplification of signal along the way.

Telecommunications providers have been able to deploy various flavors of DSL⁴ of up to 300 Mbps downstream and 100 Mbps upstream for short distances in controlled environments. Real-world speeds tend to be much slower and often do not fit the FCC or IJJA definition of broadband, making this solution more challenging for grant funding. These solutions are specific to an ISP's requirements and needs and do not work well in a multi-provider environment.

4 VDSL, Vectored VDSL, VDSL+, VDSL2 are the most widespread versions of such DSL technologies.

More advanced technologies⁵ have been implemented that can deliver gigabit speeds utilizing existing copper and cable wiring. These newer access technologies could potentially serve multiple providers, and/or allow housing developers to more easily switch preferred providers. But in order to facilitate such architectures, an entity would need to be responsible for managing this layer of connectivity between an ISP's network and the router or gateway in a home.

- **Whole building Wi-Fi**

- Wi-Fi wireless technologies allow for deployments that bypass wiring altogether. Access points can be strategically placed throughout a building to provide services, in both public and in-unit spaces.
- Interference and physical obstructions—such as concrete or metal building structures, security, and quality of service—can limit the success of a wireless solution for multi-resident buildings. An assessment would map strategic locations based on building blueprints that include wall materials and thickness in addition to physical layout
- Wireless deployments are obviously not futureproof, but lower cost than wired solutions to upgrade when needed. However, grant funds prioritize wired solutions over wireless solutions.

From an open/competitive access perspective, the ideal scenario with existing buildings is likely retrofitting, unless there are existing plans and funds for a substantial rehabilitation. A fiber-to-the-unit architecture allows for multiple ISPs to serve the residents at competitive price points. Fiber optics will help ensure all residents have acceptable levels of service at prices affordable to all income levels.

2.2.2. COST ESTIMATE DEVELOPMENT

Through stakeholder engagement process leading to a feasibility study, a cost estimate for the desired solutions can be developed for any type of housing. A network cost estimate is based on the type of technical solution and takes into consideration the following:

- Physical layout and characteristics
- Construction labor
- Materials

⁵ Alternative access technologies such as g.fast, G.hn, and MoCA have been recently deployed by a few ISPs in the United States.

- Engineering
- Permitting
- Quality control
- Testing
- Operating costs, including pole attachments, easements, licensing, electronic equipment maintenance, repairs, and replacements

The key outcomes of this phase are to understand what coverage is possible with certain technical solutions, and to produce an estimate of what it would cost to build and operate the various solutions.

2.3 Financial modeling

A financial model is a critical tool that helps public, private, and nonprofit entities understand the impact of various decisions and other factors on the potential financial cost and performance. For a broadband network, this means understanding how factors such as project financing, customer take-rate, capital costs, and a broad range of other considerations will affect the financial viability of the project. Collecting and analyzing the right information allows decision-makers to assess a range of potential scenarios and make the best-informed decisions.

The extent of the modeling required depends on financing options and the appetite for financial capital and operational risks. In a competitive bidding process with private sector providers, such calculations are undertaken by the private entities; the outcomes are the financial commitments outlined in the response to the formal request. Grant funding can heavily influence the financial modeling outcomes through shifting costs towards capital which significantly reduce ISP installation and operational costs. If a public or building-owner operated/funded service is desired, such costs would have to be detailed to capture operator risks, rewards, and financial commitments.

The financial model is designed to enable development of a pro forma, a forward-looking projection of an entity's financial picture that includes the key financial statements that an enterprise would typically maintain, including:

- **Balance sheet** – a statement of assets (what the entity owns) and liabilities (what it owes)
- **Income statement** – a statement of revenues and expenses, and how those amounts compare
- **Statement of cash flows** – a comparison of cash in and cash out on a monthly basis



Grant funding can heavily influence the financial modeling outcomes through shifting costs towards capital which significantly reduce ISP installation and operational costs. If a public or building-owner operated/funded service is desired, such costs would have to be detailed to capture operator risks, rewards, and financial commitments.

To prepare this pro forma, the key inputs to the financial model include:

- **Capital costs** – this should be estimated in the engineering phase, and is frequently represented on a per user basis
- **Operating costs** – this number should also be an output of the engineering phase, and will depend in part on the scale of the network, which affects staffing and other operational needs
- **Expected subscriber revenues** – subscriber revenues can be estimated with an expected take-rate (the percentage of people that will subscribe to the service when it is made available) and a pricing model for services; market research efforts can help determine estimated take-rates for various types of service

A well-crafted financial model will use all this data to enable projection of the potential financial performance of a project over time—in five years, 10 years, or beyond—and to evaluate potential stability. The model can also enable an understanding of how much grant and other support funding will be necessary to make a project economically feasible or to reduce financial risk.

The financial model can also enable individuals and other entities to understand the potential financial impact of changed or alternative circumstances. A quality financial model allows for evaluation of what might happen if capital costs turn out to be higher than expected, or how financial performance would be impacted by an increase in interest rates for project debt, or the impact of lower-than-expected take-rates. This ability to see how changed assumptions can impact projections allows decision-makers to better understand the risks and make appropriate decisions for the project.

2.4 Business or strategic plan development

Business and strategic plans are similar in that both provide recommendations for action steps that will move a project closer to its goals. A key difference between the two is that while strategic plans are more broadly applicable, business plans are typically prepared for entities that will be serving as an internet service provider. Business plans will include additional strategy recommendations and are shared less publicly.

Both kinds of documents outline a roadmap of next steps, often providing recommendations that address the following:

- Grant strategy, including what entity is serving as the applicant, application timelines, and program priorities

- How to allocate resources within the organization
- Key policies to adopt
- Distribution of responsibilities among partners
- Governance considerations, such as oversight responsibility
- Sourcing decisions (what is being handled in-house or by a partner, and what is being contracted out?)
- Measures of success to evaluate progress over time

Several, if not all, of these topics and decisions will likely have been touched on in an earlier phase of the project-planning process. But a formal plan provides an opportunity to specify and codify priorities, goals, and next steps. A good business or strategic plan will chart a clear path forward—with the understanding that a few bumps in the road will be inevitable.

2.5 Partnership development

Partnerships ultimately distribute risk, benefits, and control among two or more entities.

There are a variety of partnership configurations that could be developed to serve a housing project with internet service. Partnerships ultimately distribute risk, benefits, and control among two or more entities. To that end, factors to consider when having conversations with potential partners in early project stages include the entity's historical appetite for investment, track record fulfilling commitments, and how closely they have worked with past partners.

Partnerships can be public and private and can include more than two entities. Options can include developers, banks, foundations, housing departments, housing advocacy groups, tenant organizations, internet service providers, or any flavor that the various stakeholders identify as the best option for the project. Each partnership is different due to the unique needs of each project.

Partnership development can be part of the process outlined in this section or can be adjacent to the development of a community-wide broadband plan. Regardless, these partnerships will impact financial modeling and business or strategic plan development. Finally, depending on the grant source requirements, the development of public-private partnerships may be constrained by factors such as requirements to utilize a competitive process to identify non-public partners.





3

Policy overview

3.1 Federal policy impacts

Many agencies are involved with broadband development at the federal level, including but not limited to the National Telecommunications and Information Administration (NTIA), Economic Development Administration (EDA), FCC, and Department of Agriculture (USDA). Each of the agencies has different speed requirements, including some departments that have multiple variations depending on the program, and different focuses for the various funding sources. Funding flows through each agency through the forms of grants, loans, and auctions. In relationship to housing, funding sources will likely be in the form of grants and to a lesser extent, loans.

According to the FCC, an address is considered served by broadband if it has access to internet service of 25 Mbps download and 3 Mbps upload. This standard, which has not changed since being set in 2015, has been adopted by many states as the minimum for their broadband programs. The Department of Treasury set 100 Mbps upload and download as the minimal target for its recent ARPA-related funding programs, as has the more recent IIJA, although the IIJA will fund projects at 100/20 Mbps where 100/100 Mbps is impracticable. This represents a significant increase. Some grant funding follows Congress' higher speed mandate while others still use the FCC standard. It is imperative to know what the requirements are for the funding sources used.

The federal government does not dictate if local governments, nonprofits, electric co-ops, or entities that are nontraditional ISPs can develop broadband infrastructure, provide services, or enter into public private partnerships (PPP). Certain grants do, however, have limitations on ownership and how/when to engage in various forms of PPP. The federal government has historically left these regulations to the state governments.

3.2 State policy impacts

Historically, state governments have not invested in broadband infrastructure except to serve their own facilities. State governments have created significant laws and policy about broadband deployment. These include 22 states that have prohibitions on local governments engaging with broadband in some capacity; no two states are the same. It is wise to check with policy experts and legal representation to ensure supporting broadband to affordable housing does not violate these laws.



It is imperative for local agencies and nonprofits to engage with their state broadband offices for funding to deploy broadband to new affordable housing developments or retrofit existing buildings.

Due to the Covid-19 pandemic, states have been taking a more active role with broadband deployment and engaging with the deployment to underserved communities. This engagement has accelerated due to the passing of a number of programs that provide funding for broadband. Specifically, the IJA required states to develop a broadband office. These offices will grant funding to connect residents and businesses including infrastructure builds where needed. The various limitations by the states will influence the way in which grants are initiated. It is imperative for local agencies and nonprofits to engage with their state broadband offices for funding to deploy broadband to new affordable housing developments or retrofit existing buildings.

3.3 Local policy impacts

Lower-income areas, regardless of location, have traditionally seen disinvestment in the standard way of providing broadband services. Private companies, including ISPs, are in business to make money; serving low density and or low-income areas does not provide as much revenue as higher density areas with high income levels. As a result, there are gaps in services in our communities, counties, and townships. Local governments are able to impact this issue through several mechanisms.

Local policies can heavily impact broadband infrastructure development without significant cost to the local agency. Depending on the state and the prohibitions on broadband engagement, many municipalities, counties, and townships have the ability to put in place policies that will positively impact the development of broadband networks. These include, but are not limited to:

- **Enacting dig once policies** – Simply put, these policies require any utility (including public entities) to install conduit when a right-of-way, street, or the like is opened. For example, a city could require the local natural gas provider to install conduit when the natural gas company is replacing older infrastructure. The City could reimburse the natural gas company for the cost of the conduit or provide the conduit to the company to install. In doing this, over time a buried network is developed.
- **Requiring new developments to install conduit** – As part of the building and development code, any new building should also have conduit and access portals (handholes/pull boxes) installed along with all other utilities. This will allow these new facilities, businesses, or homes access when fiber optics or other wired technology reaches the neighborhoods.
- **Mapping** – As most of the of the broadband infrastructure is in the public rights-of-way, the local agency can (where allowed) and should request maps along with permitting for any telecommunications infrastructure development. This will help overcome one of the most common issues of lack of knowledge of existing infrastructure.

4

Technology overview

The quality and speed of an internet connection will vary based on the capacity and limitations of the last-mile technology used. This section presents an overview of the four most common technologies used to deliver last-mile broadband data services to homes and businesses: fiber-to-the-premises (FTTP), digital subscriber line (DSL), hybrid fiber-coaxial (HFC), and wireless.

For purposes of capacity, reliability, and scalability, FTTP is superior to all other broadband technologies. Fiber optics is also infinitely scalable, lending to futureproof networks. In a multi-resident context, a fiber-to-the-unit (FTTU) design is desired, allowing for future changes to technology and offering a competitive network for services and speeds the residents desire.

4.1 Fiber-to-the-premises (FTTP)

Fiber optic cables are the medium of choice for data transfer, as they are made of inert glass while data is moved as packets of light. Fiber has unlimited bandwidth capacity, which enables operators to offer fast download and upload speeds as well as symmetrical speeds. Fiber is also not subject to interference and does not require amplifiers to carry a signal across long distances.⁶ This is why the vast majority of the internet backbone comprises bundles of fiber cable strands.

Once a premises is connected to fiber, there is no need for significant additional infrastructure investment for decades apart from the electronics that move light across the fiber. If more bandwidth is needed, the operator need only upgrade the network electronics, rather than having to replace the cables, unlike other wired mediums.

The electronics needed to provide 1 Gbps speed to the consumer are already widely available at an affordable price, and the price of the electronics needed to support 10 Gbps across networks are declining rapidly.

In addition to being futureproof, fiber offers the advantage of its bandwidth capabilities. A strand of standard single-mode fiber optic cable has thousands of times the capacity of any other type of wired

For purposes of capacity, reliability, and scalability, fiber-to-the-premises (FTTP) is superior to all other fixed broadband technologies.

⁶ Maximum distances depend on specific electronics—six to 25 miles is typical for fiber optic access networks.

medium, and can be symmetrically allocated between upstream and downstream data flows using off-the-shelf technology.

Further, modern fiber can provide extremely low data loss within a wide range of wavelengths. Compared to a signal loss of coaxial cable, a fiber optic cable can carry a signal of equivalent capacity over several miles, without amplification, and with minimal signal loss. Weather and other environmental factors do not impact fiber cables in the ways that coaxial and copper lines are degraded by these same factors, leading to lower maintenance costs.

While electronics have a significant impact on the customer's experience, network architecture has an equal impact on the end user experience, and is much harder and more costly to update or replace. It is imperative that building developers work with the architects and engineers to ensure the network within the building is efficient and well laid out. This holds true for new builds and retrofitting of existing buildings.

Figure 1
Connecting an FTTP network to an MTE with dedicated gigabit capacities

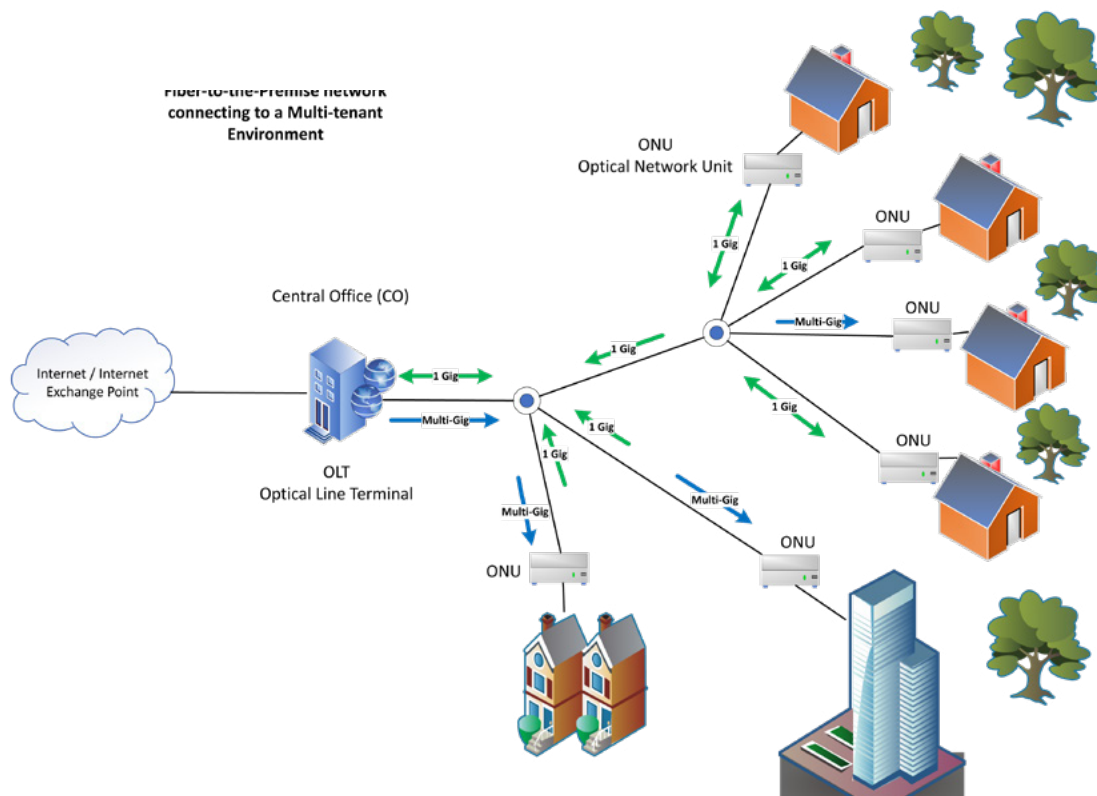

4.2 Hybrid fiber-coaxial (HFC)

Cable broadband technology is currently the primary means of delivering broadband services to homes and businesses in most of the United States. Because of its relative ubiquity in urban, suburban, and small-town areas and its inherently greater capacity than commercial wireless solutions and copper telephone lines, HFC cable networks will be the main pathway for broadband communications for most homes and businesses in areas that lack access to FTTP.

Coaxial cables were originally designed to provide video services and were sufficient in the early and mid-years of data communications, when usage was low compared to our current use. However, as demand for data capacity has increased, coaxial networks have become insufficient to support truly high-speed services. On an increasingly large scale, cable operators are now deploying fiber to replace large portions of their networks as the backbone to the coaxial cable into neighborhoods, multi-resident buildings, businesses, and single-family homes. As a result, coaxial cable networks have transformed into hybrid fiber-coaxial networks.

Although there are significant limitations inherent in systems that employ coaxial cable compared to fully fiber optic networks, cable system capabilities will increase over the next few years with the deployment of new technologies and the extension of fiber closer to customers.

HFC networks are very similar to FTTP, with a collocation where middle-mile fiber is split out by geographical area. When the fiber reaches the target geographic area, it connects at a node with equipment from where it transmits over coaxial cable and into the home, business, or facility. Coax cable can provide speeds of up to 1 Gbps download and 35-50 Mbps upload speeds, and the ability to reach those speeds is contingent upon both the age of the coaxial infrastructure and the proximity to the fiber backbone. And unlike FTTP technology, coax cable shares capacity as it splits into different buildings and units. A customer with cable infrastructure will therefore likely experience slowdowns when an entire building or neighborhood is using the internet at the same time.

Building developers should work with architects and engineers to ensure the network within the building is efficient and well laid out. This holds true for new builds and retrofitting of existing buildings.

Figure 2:
Distribution
of shared vs.
dedicated
capacity in an
HFC network

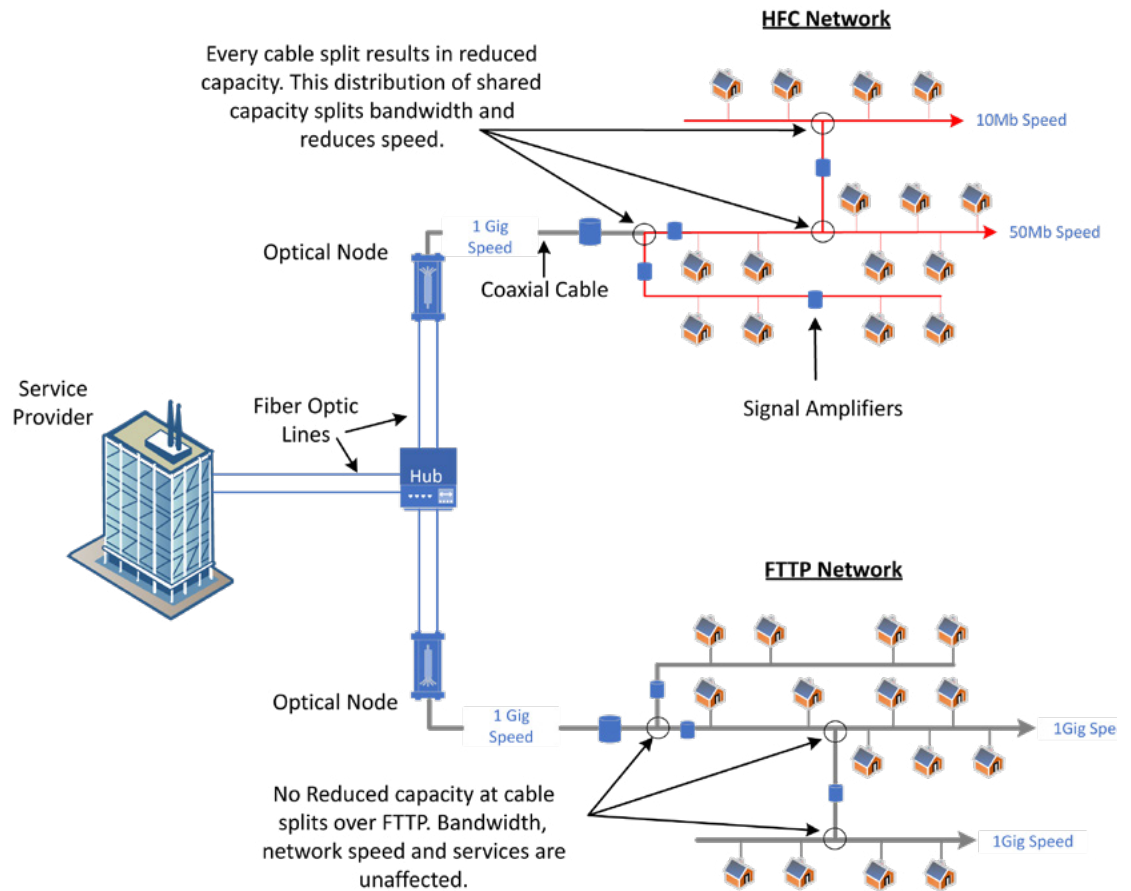

Solving the upload limitations in current deployments of HFC requires significant upgrades, but the extent of upgrades depends on the provider’s network. For the ISP to deliver symmetrical gigabit speeds over upgraded technologies while continuing to use coaxial cable to deliver services to customers, fiber will need to be deployed close to the end user, leading to the discussion and financial analysis of a switch to a FTTP.

4.3 Digital subscriber line (DSL)

During the last century, telephone companies connected virtually every home and business in the U.S. to a strand of copper wire. Because of the ubiquity of copper, digital subscriber line (DSL) technology has been an important way for people to connect to the internet.

In some scenarios, DSL operators can offer speeds that fit the FCC’s definition of broadband. However, while DSL has been an impressive retrofit of existing infrastructure, copper cable is reaching its physical limitations as a broadband medium and will not be able to meet future bandwidth needs. The main determinant of DSL speed is the length of the copper line from the telephone company central office to the aggregation point in neighborhoods. The user will experience slower speeds and greater data loss as the distance lengthens. Still, many consumers will experience download speeds between 1.5 and 6 Mbps—far short of the FCC’s standard of 25 Mbps—in more urban environments while in rural areas consumers will often experience speeds below 2 Mbps simply due to the length of the copper lines and the distance from a fibered node or signal amplifying loop extender.⁷

New investment in DSL will likely become obsolete within a decade.

Copper phone lines slowly lose the ability to transmit data as they age, and these lines are susceptible to weather and corrosion, much more so than coax cable which is also made of copper but is shielded. In rural areas, the copper infrastructure is replaced less frequently, leading to additional loss of signal and therefore services are degraded further than the speeds mentioned above. In addition, DSL also shares the same issue as coax during peak hours when more customers are using the shared bandwidth.

It is only a matter of time before the growing demand for bandwidth comes up against the physical limitations of copper as a medium for transporting data. Even if an operator can satisfy the present demand using existing copper assets, it is a significant challenge to upgrade a DSL network in a way that the majority of large-scale networks can continue to serve future demand. Many telecommunications companies are minimizing their investment in copper lines, and some are abandoning it for wireless services or migrating to FTTP. New investment in DSL will likely become obsolete within a decade.

⁷ Tyler Cooper, “DSL Internet in the USA,” BroadbandNow, March 23, 2021, <https://broadbandnow.com/DSL> (accessed January 13, 2022).

4.4 Fixed wireless overview

The high cost of building wired networks in low-density rural or low return-on-investment urban and suburban areas often leaves residents without a wired broadband option capable of delivering broadband speeds. Wireless internet service providers (WISP) are potentially able to fill these coverage gaps, sending signals from base stations to antennas on or near customer premises.

Generally, WISPs are not able to offer connection speeds on a market-wide basis comparable to cable or fiber built to each premises. While fixed wireless service is an important tool to connect the unconnected in the hardest-to-serve areas and can present a flexible and cost-effective alternative in many urban settings, fixed wireless implementations are not able to offer the quality of service that the most advanced wireline providers can provide, nor can they offer the scalability that such wired solutions can provide.

Even as wireless technologies continue to advance, they will still lag behind the performance available from fiber optics, simply because of the relative challenge in providing high-capacity connections wirelessly over long distances. Fixed wireless solutions can, however, be cost-effective alternatives for high-density urban environments, especially MTEs. Tower-to-rooftop or rooftop-to-rooftop connections with clear lines of sight can redistribute signals over in-building wire and/or via Wi-Fi access points.

WISPs often need to lease space at or near the tops of radio towers or high points in the environment, because most wireless networking solutions require the antenna at the customer premises to be in the line-of-sight of the base station antenna. However, getting a clear line-of-sight can be especially challenging in mountainous regions or areas with dense vegetation or multiple tall buildings. In those areas, some customers may be unreachable without the use of additional repeaters. Further, climate conditions like rain, heavy snow, and fog can impact the signal as it is sent through the air.

There are two main ways to deliver wireless internet service, point-to-point and point-to-multipoint. Point-to-multipoint solutions are more affordable to implement and are typically used by WISPs. However, the capacity of the network is limited, particularly in the upstream, making the service frequently inadequate for applications that require high-bandwidth connections. Equipment usually requires replacement every five to 10 years due to technology advances and exposure to the elements. Wireless equipment costs are usually lower than that of wired equipment, but this investment can increase the operating costs of broadband networks for affordable housing units in rural, suburban, and urban environments.

The quality of the wireless signal also depends on the spectrum available. Lower frequencies are better at penetrating obstructions such as foliage and buildings, while higher frequencies—which typically have larger channel bandwidths—can accommodate higher speeds for short distances. Channels in different spectrum bands can be aggregated together to increase the end user throughput. Finally, the nature of

the spectrum—regulated, lightly regulated, or unregulated—all will affect the risk of interference.

Wireless equipment available today has 100 to 250 Mbps upload capacity, but this varies widely due to those aforementioned issues—weather, line of sight, spectrum, and the quality of the equipment.

Fixed wireless systems built with off-the-shelf equipment today tend to have an aggregate capacity between 100 and 250 Mbps. With innovations like higher-order multiple input, multiple output (MIMO) antennas, and the use of spatial multiplexing, these capacities will likely increase across vendors to as fast as 750 Mbps. It is important to note, however, that this is the aggregate capacity; bandwidth will be shared among up to 200 users connected to a single base station.

4.5 Mobile broadband

Cellular wireless carriers have been consistently increasing their data speeds with the rollout of faster and higher capacity technologies, such as the fifth generation of mobile data (5G). Over the past few years, mobile carriers (ATT, T-Mobile, Verizon) have provided data plans with speeds comparable to, and in many cases greater than, a typical residential customer’s internet service. There are limitations on these plans, including data caps, lower speeds than FTTP, and slow-down in speeds when data caps are reached; a solution to this is to pay for larger data plans, but that is unattainable for many households in affordable housing.

Mobile services and wired connections are complementary. Mobile wireless services require deployment of fiber optic cable to provide backhaul to the needed dense deployments of relatively short-range but high-capacity transmitters. As these next gen technologies are rolled out, the amount of fiber expected to serve the transmitters and antenna is expected to grow exponentially. However, rural areas will face challenges in receiving this modern technology because the amount of fiber needed for 5G simply does not exist in these locations.

Mobile broadband is only available where cell service exists. Furthermore, there are some areas, particularly in rural parts of a state, where the cell service is relatively weak or where upgrades have not taken place, thereby limiting broadband to slower service with speeds comparable to telephone dial-up. While emerging 5G deployments will increase speeds in select, primarily population-dense, areas, mobile broadband have limitations due to shared capacity, associated data caps or throttling, and limitations in upload speeds.

Mobile broadband has limitations in rural areas.

5

Recommendations for housing developers

Providing high-speed data services to affordable housing units requires an extension of communications infrastructure to and within the premises. As discussed in the technical overview below, single-family homes have a direct connection via conduit to the fiber in the right-of-way. Attached housing, such as townhomes or duplex/triplexes, uses a similar model, requiring an extension of fiber from the right-of-way to the neighborhood and then into each unit, as they typically do not have a central telecommunications point.

Buildings with multiple units have other challenges that attached housing and single-family homes do not, due to the nature of the number of units, typically without access to the right-of-way. Most frequently with MTEs, fiber is extended from the right-of-way to a central telecommunications distribution point, and then to individual units. As discussed elsewhere, this can be done during new construction or as a retrofit/renovation. A building telecommunications distribution point is vital to the ability for ISPs to reach the end users and should be developed during engineering. Please see Section 6 for technical information.

The cost of serving potential customers can be lowered by building a direct path from the unit to the right-of-way—an approach that should be part of any design and engineering plan—because it reduces the need for a telecommunications distribution point. Costs can be reduced further by installing the path during other construction or renovation rather than retrofitting the building solely for network deployment.

One significant barrier for a new network provider is the ability to access the building entrance, the physical entry point for the fiber optic cable. If a building lacks spare fiber entrances and lateral conduit, underground construction and new penetrations for buried fiber will be required. The additional construction is expensive and time-consuming, and increases risk, in addition to any easements needed to access the buried fiber in the right-of-way.

In aerial fiber construction to the building, usually a fiber optic line is strung from the nearest pole to the building, much like the way in which cable TV or telephone service is provided by the local providers. The fiber optic line is attached to the building facade and then penetrates the building wall.

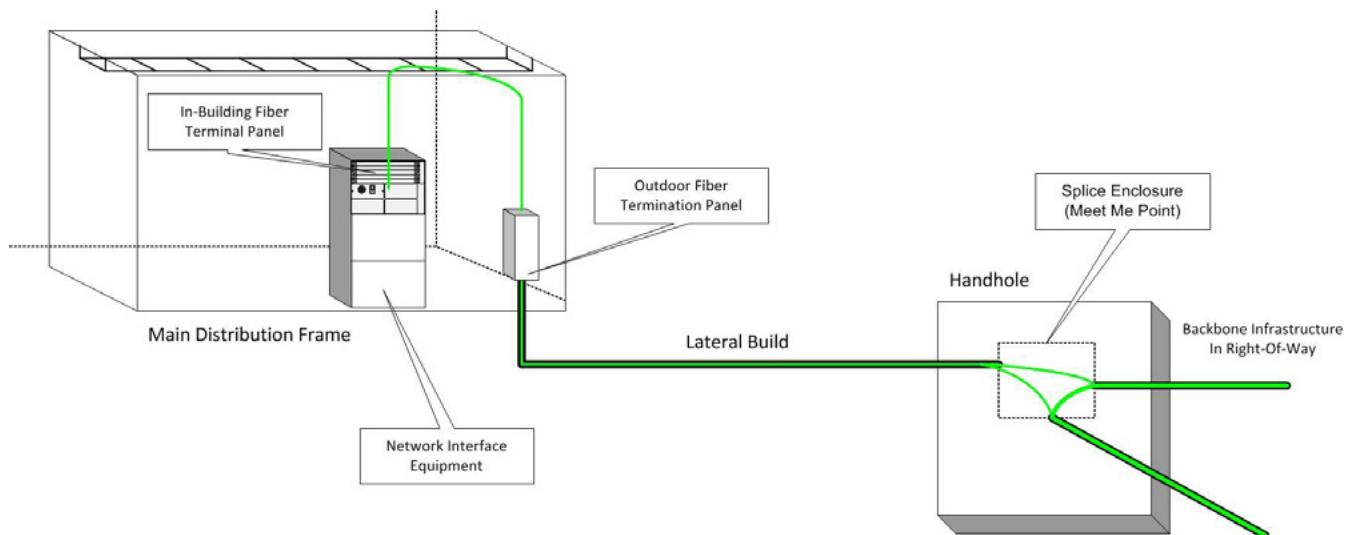

Figure 3
Detailed diagram of
lateral construction
components

When constructing new facilities, building entrances and lateral conduit should be designed and built during construction of the building. In new construction, conduit is installed during the foundation and earthwork phases of construction and later connected to the telecommunications distribution point. Developers and builders are already accustomed to providing pathways for telephone, power, and cable TV from the property line to a room designated for utility services within the building, so the requirement of an additional access point for fiber optics should be simple. The size and other technical aspects should be done during the engineer phase of construction.

Developers and public agencies can lower the barriers for telecommunications companies to offer tenants high-speed broadband services by designing and constructing additional conduit when constructing a new site. Installing the conduit during the construction of the building has several benefits, including:

- The cost of constructing conduit is cheapest when it is an incremental addition to the construction of the building;
- The conduit can be used by any provider that wishes to provide services to the building's tenants and is not owned by a particular telecommunications provider;
- The conduit decreases the time and cost required to provide services to the building, which decreases the cost of broadband services for the tenants;

- Multiple providers can share the same conduit, which allows tenants to competitively shop for broadband services;
- The availability of multiple telecommunication providers can be marketed to tenants as an amenity.

The incremental cost to add an additional conduit for fiber optic cable in the same trench as the other utilities is relatively low. Adding a 200-foot path from a building's utility room to the property line would cost approximately \$2 per foot for labor and \$2 per foot for materials—or approximately \$1,000 in additional construction costs for the installation of conduit into the building (Figure 3).

In contrast, the cost of the same 200-foot route for construction into an existing building can range from \$1,500 to \$10,000. The higher cost is realistic if the fiber optic in the right-of-way is significant distance from the building or if construction crosses additional built environments such as parking lots or driveways due to the cost of restoration or underground boring. Environmental challenges including rocky soil, wetlands, waterways, open spaces, can significantly increase the cost of bringing fiber to existing buildings. Constructing a new route into an existing building may also involve days or weeks of delay for design, engineering, permitting, utility location, coordination with the building owner, and inspections.

It is much preferable to plan for advanced telecommunications infrastructure when building new affordable housing. However, much of the affordable housing across the country is older and will need creative ways to ensure fiber optic lines are brought to the buildings to ensure affordable and abundant broadband services for the residents.

6

Overview of infrastructure construction

The following sections describe some of the technical aspects of deploying fiber-based solutions to housing units, both for multi-tenant environments, attached housing, and single-family homes. These technologies can be utilized to retrofit MTEs. Retrofitting attached housing and single-family affordable housing is a more significant challenge and will take engaging with the local public agencies and/or local electric utilities to bring fiber optics to these buildings.

6.1 What is conduit?

Conduit is essentially a pipe composed of high grade plastic, that is placed underground to house fiber optic lines and protect it from environmental factors (water, rocks, mud), as well as from stress and pressure created by traffic above ground (Figure 4). Most importantly, conduit provides a path for easily replacing, repairing, or installing additional fiber. While it is possible to directly bury many types of communications cables, conduit allows cables to be replaced or upgraded without most of the costs associated with physical construction.

Conduit can be placed along rights-of-way, buried under gravel or paved roads and connect to individual buildings. Conduit is placed at the time of underground construction and fiber is installed after conduit construction is complete. Forward-looking property developers and local governments will place conduit at the time of road construction or property development to meet known needs or to meet anticipated future needs.

Conduit is typically manufactured with rigid polyvinyl chlorate (PVC) or flexible High Density Polyethylene (HDPE). Depending on the application of the conduit and the areas in which it is placed, different grades of conduit may be utilized. For instance, a lower grade of conduit can be used in non traffic areas or areas in which only light pedestrian traffic typically occurs, whereas steel conduit might be used under a train track.

Rigid PVC conduit, manufactured in sections and joined with coupler, is generally only installed in

What is conduit?

Conduit is a plastic pipe placed underground to protect fiber from the elements.

Figure 4
Rolled duct HDPE conduit.

Figure 5
Conduit being installed in an open trench.

Figure 6
typical pullbox installed in the right-of-way.

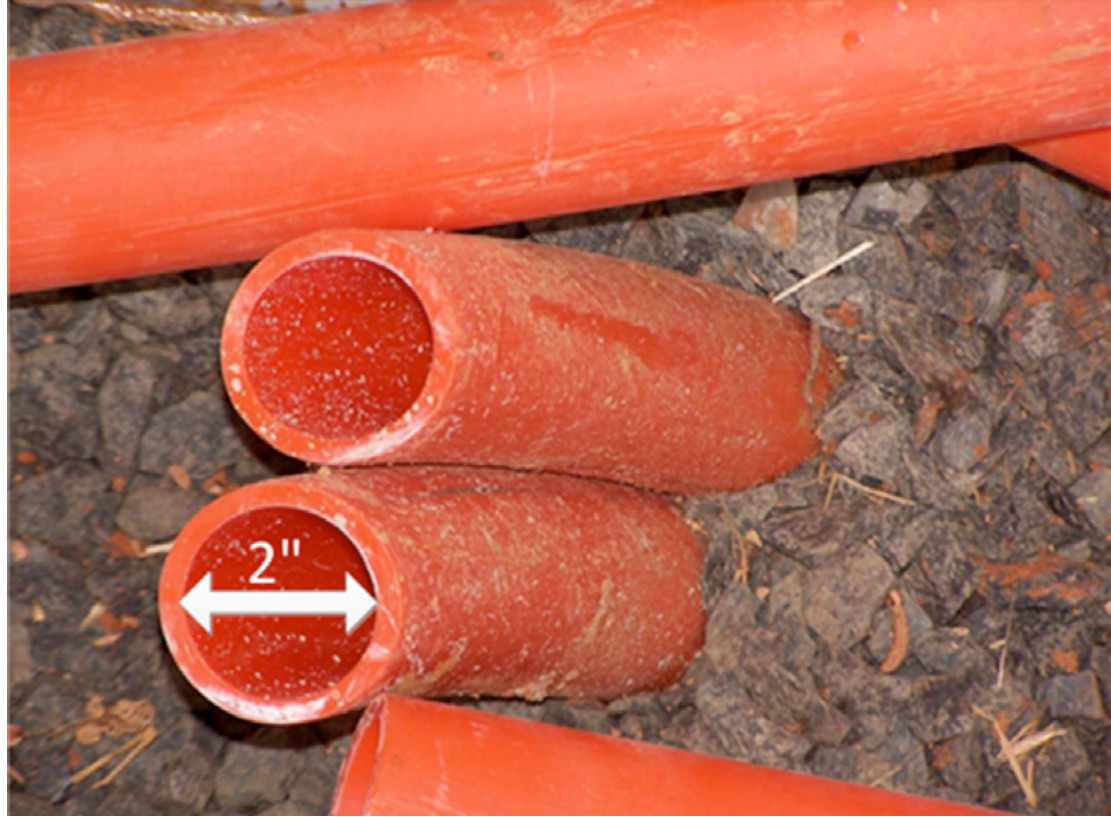

open trenches (Figure 5). Flexible HDPE conduit, available on reels in lengths of several thousand feet, can be installed in trenches, directly “plowed” into the ground, or placed with directional boring.

Pullboxes (also called handholes or vaults) are installed along a fiber route in regular intervals (500 to 1,500 feet) to provide access to conduit for fiber placement or to house splice enclosures in underground construction (Figure 6). For a variety of purposes, these include.

- Housing excess fiber that provides slack for repairs or future splicing work;
- Relieving the friction that occurs in long runs of fiber pulled through conduit;
- Providing access to conduit for placing new cable; and
- Providing access to fiber for splicing.

Pullboxes are often strategically placed in locations where future sites may branch off from a high count backbone cable, allowing a new conduit/cable to join the backbone without disturbing the backbone conduit.

6.2 Fiber optic construction in the right-of-way

Communications providers and some local/state governments typically install fiber optic infrastructure in existing public rights-of-way. The right-of-way is land owned by the local or state government that has been designated for the installation of infrastructure and utilities such as roads, sidewalks, wastewater, water, gas, and communications. The right-of-way is typically under or on the side of public streets.

Underground fiber optic construction usually occurs in conduit located outside of the roadways where rights-of-way allow while pullboxes are generally located in the greenways or shoulders of roadways. During the fiber development design and engineering, pullboxes are often located or added where connections to potential customers can be made. If developers have already constructed lateral conduit from buildings to the right-of-way, a pullbox can be installed so fiber can be installed into the building.

Road construction or building development provide opportunities for less expensive fiber construction, as conduit construction can be coordinated with the placement of other utilities while trenches are open. Conduit can be installed before driveways and sidewalks are placed and surfaces are landscaped making these neighborhoods, and businesses fiber ready.

6.3 Outdoor wiring fiber termination points

Indoor wiring can be a complicated and expensive endeavor if the building entrance location is distant from the location where the outdoor fiber will be terminated. Generally, innerduct or conduit must be installed inside the building to provide a path for the cable installation. If the distance is greater than 50

feet, the outdoor cable must be spliced to a cable with proper indoor ratings (primarily relating to the toxicity of the fumes generated if the cable burns), or the cable must be placed within electrical metallic tubing (EMT).



Figure 7: Wall-mounted fiber termination cabinet

The outdoor fiber may be terminated in a wide range of available fiber termination cabinets, whether wall-mounted (Figure 7) or within an equipment rack, containing connectors manufactured with small fiber pigtailed, splice trays to house splices between pigtailed and the fiber cable, and cable management equipment.

6.4 In-building wiring

This section provides recommendations for in-building wiring that can work effectively with the outdoor cabling and is scalable for future needs. In an approach consistent with industry standards (in particular, ANSI/TIA-568-C), a Main Distribution Frame (MDF)—a central telecommunications distribution point for in-building cabling and termination of outdoor cabling—is placed in the building in a secure centralized wiring room (Figure 8) near the building entry. The room is connected to the building entrance, outdoor conduit, and fiber infrastructure over the lateral conduit. The room includes equipment racks for electronics and fiber termination, and uninterruptible power supplies (UPS). Racks should also have separate lockable partitions for multiple service providers.

Each building should also house Intermediate Distribution Frame (IDF) locations—these are intermediate wiring and equipment closets typically on each floor or in each major portion of the building, no more than 270 feet from the farthest wiring endpoint. This approach works with a wide range of network architectures and electronics, is compatible with open access, provides logical points of demarcation between building owner and service provider, and is scalable.

The pathways between MDFs, IDFs, and tenants also need to meet industry standards (TIA/ANSI) so that bend radius, distances, clearances, and locations of termination points are correct for the potential range of technologies that might be installed.

Figure 8
Main distribution
frame layout

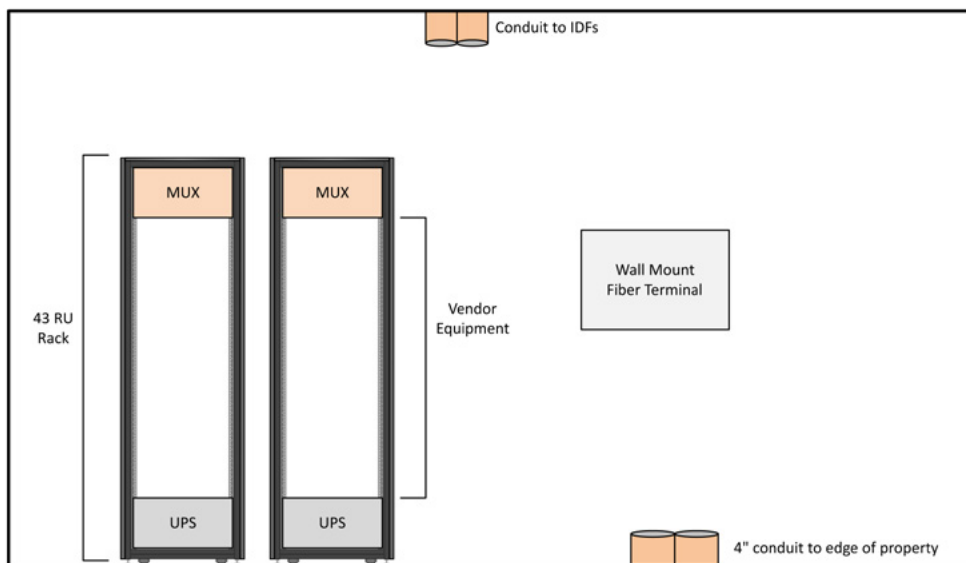

6.4.1. RESIDENTIAL BUILDINGS WITH SHARED ENTRANCES

In residential buildings, we recommend a cabling approach that can provide two internal single-mode fibers from the MDF to each unit. Fiber can enter the building via the developer's lateral conduit to the right-of-way and either be patched through the MDF and IDFs, or pass through electronics or splitters at those locations.

Each building should have sufficient conduit from the MDF to the right-of-way to enable multiple service providers to enter, using a range of network architectures. In a large building, with 100 or more apartments, at least four 2-inch conduit or the equivalent capacity in other sizes should be installed, in addition to conduit already allocated to phone cable and other service providers at the time of construction. In smaller residential buildings, two 2-inch spare conduit may suffice.

In retrofitted MDUs there may not be easy pathways from each unit to the IDF (Figure 9). In this scenario, cable raceways may need to be installed within the common areas such as hallways to reach each unit. These cable raceways can be designed to have minimal impact on the building aesthetics.

Figure 9
Indoor cabling
overview for
residential
buildings

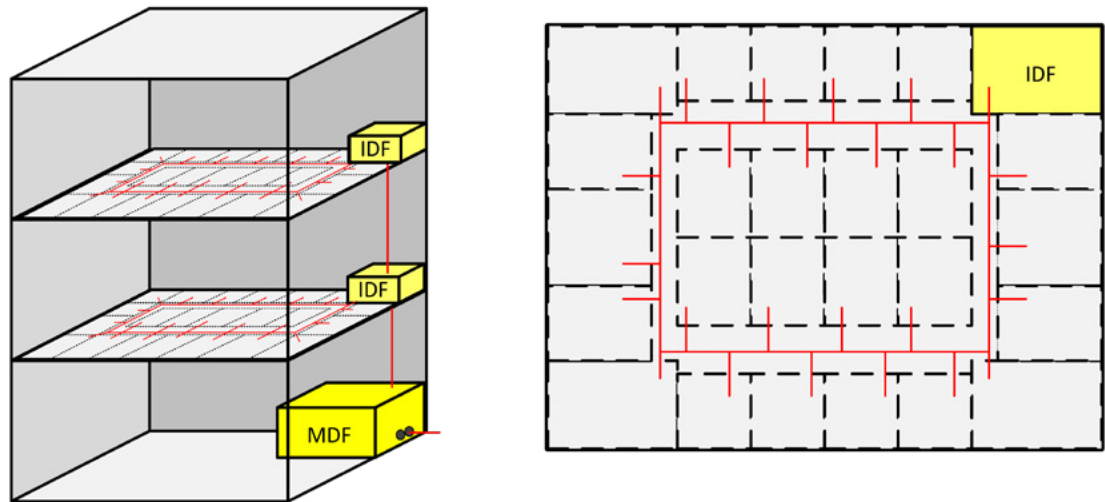

6.4.2. RESIDENTIAL BUILDINGS WITH SEPARATE ENTRANCES

Smaller MDUs with separate entrances into each unit often do not have a MDF or IDFs. During new construction fiber can be pulled to each unit from a central location on the property. Telecommunications providers may need to install external equipment shelters to house and power equipment to provide broadband services. When building are retrofitted, there may not be pathways for pulling in new inside wiring. Often times that new wiring must be installed to the outside of the MDU and within cable raceways and then pulled into units through an exterior wall (Figure 10).

Figure 10
Conduit and
pathways for
separate-
entrance
housing units



6.4.3. SINGLE-FAMILY HOMES AND TOWNHOMES

Single family homes and townhouses can be the most expensive to provide broadband service to as the cost generally goes up as the density decreases. The cost to serve the units can also change depending on the distance from a provider's existing network, requiring extensive fiber lateral construction—which will be the most important factor in determining the cost to serve each unit. These buildings do not have shared entrances or other common spaces, so fiber would be constructed to each unit. Figure 11 illustrates this model.

Figure 11
Standalone Unit
Broadband Model

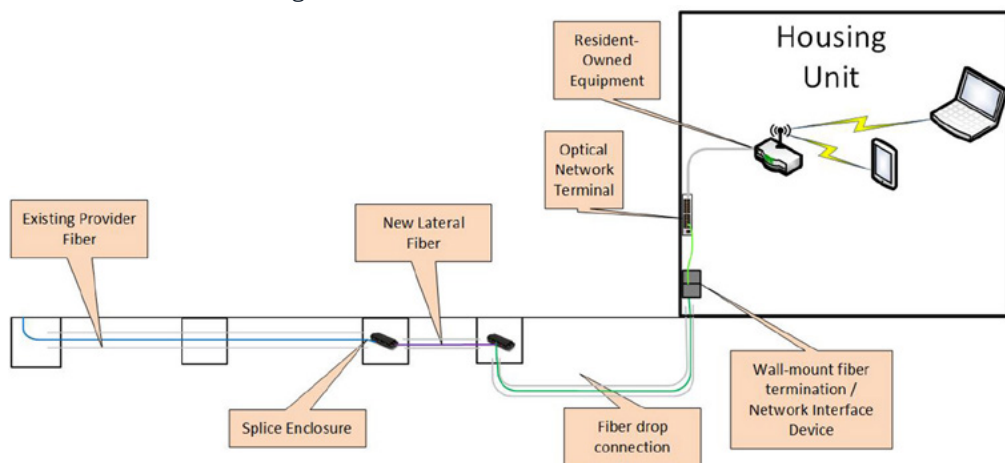

It is much preferable to plan for advanced telecommunications infrastructure when building new affordable housing. However, much of the affordable housing across the country is older and will need creative ways to ensure fiber optic lines are brought to the buildings to ensure affordable and abundant broadband services for the residents.



7

Supporting digital inclusion

Even once broadband infrastructure is built and service is available, there often remain barriers to equitable internet use. In particular, lack of access to affordable internet-connected devices and lack of digital skills can keep individuals from being able to fully participate in online life. Housing developers can consider partnerships with entities that have this expertise to help residents access such resources. For example:

- **Alliance for Technology Refurbishing & Reuse:** This organization supports a network of nonprofit technology refurbishers and recyclers. The network includes 95 organizations across the country that help make no- and low-cost devices available to those in need.
- **PCs for People:** PCs for People is a nonprofit that helps make low-cost computers and affordable internet service available to qualifying low-income individuals and nonprofits.
- **TechSoup:** This organization provides software, hardware, and technology services to nonprofits, foundations, and libraries.
- **Local libraries:** Libraries are community anchor institutions and often offer opportunities for digital skills training and other support.
- **Local Workforce Centers** and **Adult Education** organizations: These may have classes to help individuals overcome digital literacy challenges.

Housing developers can consider partnerships with entities that have this expertise to help residents access digital inclusion resources.



7.1 Case study

City of Seattle

Since 1997, the City of Seattle has offered a Technology Matching Fund to support local organizations working to close the digital divide. With an annual budget today of \$320,000, the fund provides up to \$25,000 each to an average of 12 community organizations per year.⁸ The organizations agree to a 1:1 match through contributions of volunteer labor, materials, professional services, or cash (Figure 12).⁹

TIMELINE ►
Figure 12
Seattle's History of
Advancing Digital Equity
and Fostering Best-in-Class
Internet Infrastructure

YEAR	EVENT
1994-5	Opened its first public computer labs .
1997	Started Technology Matching Fund in 1997; \$5.7 million in grants have been awarded.
1999	Created the Cable Customer Bill of Rights to ensure responsive service from cable companies.
2000	Developed Goals for a Technology Healthy Community that led to the first community survey .
2010	Began efforts that led to low-income internet discount programs .
2012	Allowed its fiber optic cable network's excess capacity to be used for high-speed internet .
2014	Passed an ordinance to reduce barriers for new market entrants.
2015	Launched Digital Equity Initiative .
	Modernized the Cable Code, partly to ensure build-out to low-income households .
2016	Launched Digital Equity Initiative Action Plan .
	Built out public Wi-Fi inside community centers , with initial funding support from Google.

⁸ Technology Matching Fund, City of Seattle, <https://www.seattle.gov/tech/initiatives/digital-equity/technology-matching-fund> (accessed November 2020).

⁹ Source: <https://durkan.seattle.gov/wp-content/uploads/sites/9/2020/09/Internet-for-All-Seattle-Report-FINAL.pdf>, Appendix A (accessed December 7, 2020)

David Keyes, Digital Equity Manager for the City, pointed out some of beneficial effects of implementing the fund:

- Increased capacity among grassroots organizations working on digital inclusion initiatives.
- Built more trust among the organizations.
- Established better understanding of the needs of target population groups.¹⁰

The fund's review panel consists of a mix of City staff and community leaders to ensure that funded projects are responsive to community needs while accomplishing the City's digital inclusion objectives. He emphasized the value of working with those organizations already providing services to target communities to help them incorporate broadband adoption initiatives into their offerings. Getting assessment data back from partners can be a challenge, so Mr. Keyes tries to learn about their existing data collection practices in order to understand where there may be opportunities to gather key statistics. The City strives to use its data collection process to deliver useful data back to community partners that they can then use to pursue other funding opportunities.

The City conducts regular technology access and adoption studies. It launched a Digital Equity Initiative in 2015,¹¹ followed by a Digital Equity Initiative Action Plan the next year.¹² In the plan, the City set three priorities for itself:

- Provide high-quality devices and technical support.
- Ensure available, affordable internet connectivity.
- Deliver technology training opportunities to all residents.

The City divided its strategies into discrete action items and regularly updates its plan to reflect progress made on each action item.¹³ Seattle is also working to ensure that all Seattle residents have the digital skills necessary for full participation in society. The City partnered with researchers at the University of Washington to identify and compare digital skills and competencies recommended by fifteen popular frameworks and curricula. They have published their findings,¹⁴ and continue to work on establishing well-defined digital competency standards and assessment tools that can be used across City departments and community organizations.

10 David Keyes (Digital Equity Manager, City of Seattle), telephone interview, November 9, 2020.

11 Digital Equity, City of Seattle, <http://www.seattle.gov/tech/initiatives/digital-equity> (accessed November 2020).

12 "Digital Equity Initiative Action Plan, Phase 2," City of Seattle, https://www.seattle.gov/Documents/Departments/Tech/DigitalEquity_PhaseII.pdf (accessed November 2020).

13 "Internet For All Seattle Report," City of Seattle, September 2020, <https://durkan.seattle.gov/wp-content/uploads/sites/9/2020/09/Internet-for-All-Seattle-Report-FINAL.pdf> (accessed November 2020).

14 Stacey Wedlake, et al., "Digital Skill Sets for Diverse Users," Social Science Research Network, July 19, 2019, <https://ssrn.com/abstract=3427252> (accessed November 2020).



7.2 Case study

City of Portland, Oregon

Since 2014, the City of Portland has worked in close collaboration with Multnomah County and the Library to address barriers to digital inclusion. City staff helped convene the Digital Inclusion Network (DIN)¹⁵, and the DIN developed a Digital Equity Action Plan (DEAP) in 2016¹⁶ to set the digital equity agenda for City departments and supporting partners to pursue for the next three years (Figure 13).¹⁷

The City is working on a digital inclusiveness index for households in order to make it easier to track where progress is being made and will provide more support to coalition members in gathering data during the implementation of the next three-year plan.

The City worked closely with the community to set the agenda and strategy laid out in the DEAP. In the next iteration of the plan, they are working to create structures that will allow community members and organizations to take the lead on some strategic action items. Community organizations volunteered to take on responsibility for implementing various aspects of the first DEAP, but there was no accountability mechanism built in to remind the community partners of their commitments. The City, County and Library have all made progress on their strategic action items, but they are hoping to get more community buy-in during the implementation of the next three-year strategic plan.

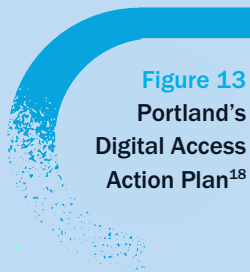

Figure 13
Portland's
Digital Access
Action Plan¹⁸

GOAL AREA

1. Access
2. Support and Training
3. Leadership and Capacity Building
4. Connecting to the Digital Economy

ACTION PLANNED

- Ensure access to affordable highspeed Internet and devices for those in need.
- Provide training and support to ensure that everyone has the skills to use digital technology to enhance their quality of life.
- Empower community partners to bridge the digital divide through funding, coordination, training, and staff resources.
- Create opportunities for jobs in the digital economy for underserved populations.

¹⁵ Digital Inclusion Network, City of Portland, <https://www.portlandoregon.gov/oct/73860> (accessed November 2020).

¹⁶ "Digital Equity Action Plan," City of Portland, April 2016. <https://www.portlandoregon.gov/oct/article/643895> (accessed November 2020).

¹⁷ Source: <https://www.portlandoregon.gov/oct/article/643895> (accessed December 7, 2020).



7.3 Case study

Detroit, Michigan

In 2019, the City of Detroit undertook a monumental goal: to become the country's leading city in digital inclusion efforts. Led by Mayor Mike Duggan and the Detroit City Council the city recognized that it was lagging far behind its peers when it came to being a digitally inclusive place for its citizens. The city was facing some truly staggering digital divide challenges: 19% of its citizens were connecting to the internet through cell phones only; 46% of Detroiters did not have a desktop computer or a laptop; and anywhere between 25-30% of inhabitants lacked internet connectivity of any kind.

After a year of planning, meetings, and community involvement, Detroit rolled out one of the country's first comprehensive digital inclusion strategies. To spearhead those efforts, the nation's first Digital Inclusion Director, Joshua Edmonds, was appointed just in time to address the challenges raised by the COVID pandemic in early 2020. Edmonds was able to quickly turn the city's digital inclusion plan into action, just as schools and businesses were shutting down. Other partners were brought in to help, including groups like Human-I-T, a nonprofit digital inclusion group based out of Los Angeles but with roots in Michigan. With the support of the city, Human-I-T opened a computer refurbishing warehouse in Detroit to provide devices and other digital inclusion services: tech support, digital literacy, and hotspot deployment.

By the end of 2021, Detroit had successfully turned federal funding assistance into concrete results: it deployed over 75,000 computers to Detroiters in need and connected the greatest share of its citizens to the federal government's Emergency Broadband Benefit program to subsidize internet connectivity to low-income individuals and households. To ensure sustainability and scale going forward, Detroit launched Connect 313, a data-driven digital inclusion initiative to ensure all Detroiters can access the digital world and the opportunity it brings. While systemic challenges remain, Detroit is firmly on a path to a digitally inclusive future for all its citizens.





Funding opportunities for broadband

There are several federal funding opportunities available to support broadband deployment in multi-tenant environments. Most of these programs are intended to serve rural areas, but others can be applied in the urban context as well. Funding opportunities fall into several distinct categories: Infrastructure, Economic Development, Digital Equity, Subscription Support, and Digital Device programs.

8.1 Infrastructure

While previous broadband infrastructure projects were limited to rural areas, new programs offered directly from NTIA and other federal agencies expand eligibility to any homes without reliable fixed wired broadband connectivity. Retrofitting projects where current inhabitants have to rely on inferior DSL options are therefore prime candidates for such grants. These projects lend themselves well to building out a more comprehensive infrastructure that connects many such MTEs with fiber bringing connectivity to an aggregation point and retrofit the interior for a fiber-to-the-unit architecture. MTE owners and developers can partner with their local government and one or more ISPs to apply for such grants.

These grant programs include:

- **American Rescue Plan Act's State and Local Fiscal Recovery Funds** are some of the most flexible funding sources and are also ideally placed to fund such projects. These programs transfer funds to state and local governments, which then decide how to use them. As long as projects primarily target unserved locations, eligible uses are quite flexible and can include infrastructure as well as adoption-focused expenses.
- **USDA ReConnect program** is designed to address unserved locations in rural areas and could potentially be a source for such infrastructure projects. They are primarily designed for government and provider partnerships. This program has a complex set of requirements and high scoring on an application requires minimizing inclusion of already served locations, currently available speeds below 25/3, and wired solutions. Middle-mile and backhaul connections are eligible however and projects that interconnect with other anchor institutions would have higher scoring.

- **Other federal infrastructure projects** managed by NTIA are similarly focused on unserved locations but aren't restricted to rural areas. NTIA also includes grants targeting tribal areas which tend to be somewhat more flexible and have low grant match requirements. NTIA's Tribal Broadband Connectivity program offers a combination of broadband infrastructure and digital equity program funding, with significant flexibility to design broadband projects to meet the distinct needs of Tribal communities and local housing.
- The Office of Public and Indian Housing (PIH) also runs programs oriented towards modernizing housing, such as the **HOPE VI program** and the **Indian Community Development Block Grant Program**.¹⁸ These programs and are prime sources of funding for such MTE projects.

8.2 Economic development

In the context of economic development, federal grant programs and private funders are primarily concerned with community impact, which therefore also lend themselves well to larger visions of broadband infrastructure targeted toward economically marginalized sectors. Such projects can also include adoption-oriented interventions such as technical classes and device lending programs. The approach in such projects would be to frame the projects in terms of beneficial socioeconomic impact on historically marginalized groups. These federal funding sources include:

- EDA's **Public Works and Economic Adjustment Assistance Program**. EDA requires built assets to be owned by public sector or non-profit applicants, but if needed, infrastructure can be transferred through long-term leases to private entities, as long as such arrangements go through competitive bid processes.
- HUD's **Community Development Block Grant (CDBG)** and **Section 108 Loan Guarantee Programs**.
- The **Appalachian Regional Commission (ARC)** also funds broadband infrastructure programs in eligible areas with the same kind of economic impact focus.
- **The New Markets Tax Credit (NMTC)** may also provide a source of revenue for broadband investments by incentivizing local private corporations to invest in upgraded infrastructure in exchange for tax credits.

¹⁸ "Grants," U.S. Department of Housing and Urban Development, Public and Indian Housing, https://www.hud.gov/program_offices/public_indian_housing/grants (accessed January 3, 2022).

- **Opportunity and Enterprise Zones Tax Credits** are another opportunity. Investments in affordable housing and broadband development have been increasingly targeting areas covered by enterprise and opportunity zones to take advantage of tax breaks and invest in social benefit infrastructure.

HUD maintains a map of all the [Opportunity Zones](#) in the US by state and census tract. The local Economic Development District or State department of Economic Development will have more information on investments in Opportunity Zones.

Enterprise Zones are distressed geographic areas that granted state tax breaks, regulatory exemptions, or other support to encourage private investment for economic development and job creation. These are managed on a state-by-state basis typically by Economic Development Districts, sometimes they are called empowerment zones or a state specific name, like Michigan's "Renaissance Zones".

8.3 Digital equity/adoption stimulation

New digital equity funding is primarily oriented toward adoption and affordability programs but allow for certain devices that could include wireless access points and routers. It is therefore feasible that some of the costs of wireless networks could be eligible in such programs. Bulk buying of broadband service may also be eligible in some programs and could be packaged with an infrastructure build to guarantee a take-rate that can allow a private provider to reduce the amount of support for capital funding needed. Funding programs that are targeting multi-function computing centers can also be utilized creatively to cover some of the infrastructure expenses. Converting areas in MTEs to a community computing center with staffed health, work, and training services for example, can fund the fiber drop and backhaul as well as part of the equipment space infrastructure and thereby substantially reduce retrofitting costs internal wiring in the MTE. Such projects would be ideal collaborations between local government, health, housing, IT, MTE owner and private partners. Public and Indian Housing's **Operating Fund** is rather flexible and can be used for computing centers that can fund similar infrastructure.

The **Neighborhood Networks Initiative** has established Neighborhood Networks computer centers to benefit low- and moderate-income residents living in privately owned HUD-supported multifamily housing.

8.4 Subscription support and affordability interventions

Existing federal and state subscription support programs can be used to help fund operations of free or discounted broadband service if structured appropriately. Such programs have the effect of driving up subscription rates (take-rates).

The **Affordability Connectivity Program** (ACP), which is the successor to the Emergency Broadband Benefits (EBB) program, is structured so eligibility is determined at the individual or household levels and require household application to the ISP. Since these are organized as discounts directly applied by ISPs and for which ISPs are reimbursed, a public or MTE owner service provider that wishes to take advantage of such programs would have to provide a paid rather than free service. A voucher program could then be provided to unit occupants to secure services for substantially reduced service and free service if they request ACP discount.

The **Emergency Connectivity Fund** (ECF) is a \$7.17 billion FCC program to help schools and libraries provide tools and services to enable communities to support remote learning during the Covid-19 pandemic. The ECF program can cover reasonable costs of laptop and tablet computers, Wi-Fi hotspots, and routers for eligible schools and libraries. Schools and libraries can also apply to receive funding for commercially available broadband services that provide a fixed or mobile connection for off-campus use to students, educators, and library patrons. The program can help address the Homework Gap for students who lack necessary access to devices or the Internet to engage in remote learning.

State programs may also have their own subsidy programs. The state of Maryland, for example, has created its Maryland Emergency Broadband Benefit Subsidy Program, which provides an additional up to \$15 per subscriber that qualifies for ACP.¹⁹

8.5 Device distribution

Device lending or distribution programs, such as Department of Treasury's Digital Connectivity Technology Projects in the Capital Projects Fund are oriented toward ensuring effective and affordable use of broadband service and are therefore ideally paired with training and other support services. In some cases, such programs could also cover costs for routers and access points, defraying what would otherwise be rental expenses to the unit subscriber, or if such costs would have been absorbed by the service provider, it would effectively subsidize operational costs. A standard generic gateway could work well in an open access or multi-service provider environment. Some of these funding programs are administered directly by federal agencies while others are administered by states. Working with local government as partners may be a requirement for such projects.

¹⁹ <https://dhcd.maryland.gov/Broadband/Pages/default.aspx>



Conclusion

Broadband infrastructure is not classified as a critical, and therefore federally regulated, utility in the way water, sewer, gas, and electricity are. Yet, it has emerged as exactly that from the perspective of users and policy makers. In the affordable housing space, broadband has not always been incorporated in planning and building housing, which has left many existing affordable housing units in rural and urban areas alike without true broadband access at affordable pricing. Housing developers, public entities, and housing authorities partnering together can positively impact the implementation of projects that support a competitive, accessible broadband environment for residents. This handbook strives to outline the various elements to take into consideration when developing new or retrofitting multi resident housing.

RURAL LISC

Caitlin Cain | ccain@lisc.org

LISC VP and Rural Director

Christa Vinson | cvinson@lisc.org

Rural LISC Broadband & Infrastructure Pillar Lead